



Flerstrengssystem

SCAN-TECH er leveringsdygtig i følgende typer smøresystemer:

1- strengs olie- og fedt- systemer med injektorer

2- strengs fedtsystemer

Levnedsmiddelsystemer

Progressive systemer

Flerstrengssystemer

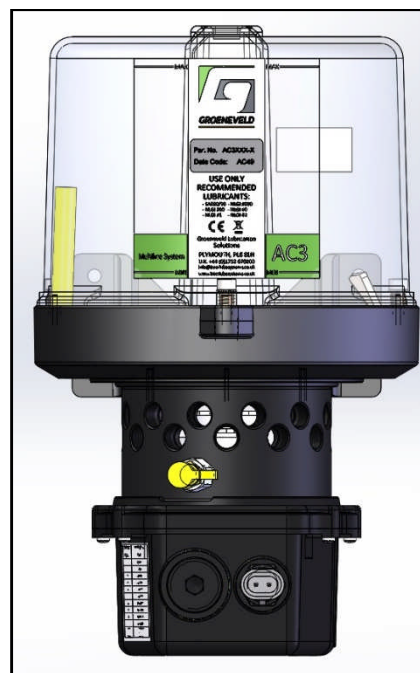

Fordelene ved centralsmøring er:

- **Optimal smøring af alle smøresteder**
- **Fleksibel systemopbygning**
- **Billig forebyggende vedligeholdelse**
- **Smøresystem for fedt og olie**
- **Et servicevenligt produkt**

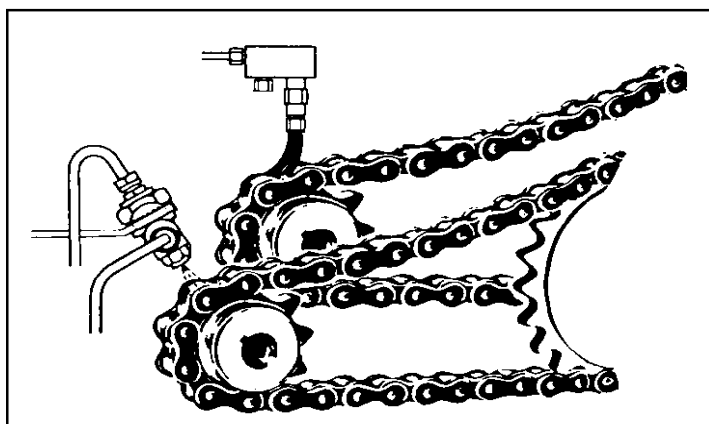

SCAN-TECH, Handel & Montage ApS
Mads Clausens Vej 28
DK 9800 Hjørring
Tlf. +4598442915
E-mail: mail@scan-tech.org
Web: www.scan-ech.org

Katalog 6-20020

Flerstrengssystem

Det billigste alternativ for anvendelse af olie og fedt.

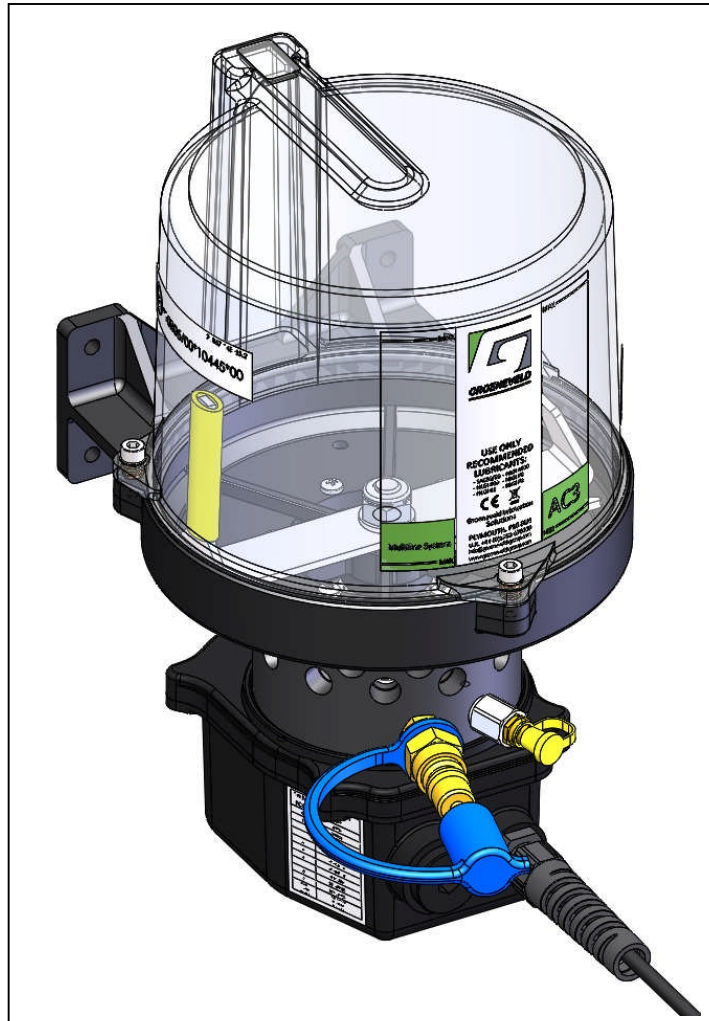

Fordele ved en kompakt konstruktion.

Flerstrengspumpen er den mest kompakte og billige form for automatisk centralsmøring. Smøremiddelpumpen er forsynet med doseringselementer, der via rørledninger er direkte forbundet til smørestederne.

Farvekode viser smøremiddelmængden.

Doseringselementer fås med 6 forskellige faste doseringer. Fra min. 1,08 cm³ til max. 10,8 cm³ pr. time.

Farve ringene på doseringselementerne indikerer det enkelte elements ydelse.

Tekniske data for Pumpe model AC 3.

Timer indstillingen og beskrivelse af el montering er vist på siden af pumpen

◆ Max højde:	313 mm.	◆ Smøremiddel:	SEA 80/90 til NLGI 2.
◆ Dybde:	220 mm.	◆ Motor indeks:	24 volt DC.
◆ Antal udtag:	1 til 60 stk.	◆ Strømforbrug:	0,4 A.
◆ Max. driftryk:	125 bar.	◆ Reservoir:	3 liter.
◆ Omdr. tal:	108 omdr. pr. time.	◆ Timer:	Indbygget i pumpen.
◆ Pumpeelementer:	6 forskellige størrelser.	◆ Rørtilslutning:	4 mm.

Tekniske data for pumpeelementerne:

Bestemmelse af pumpeelementer.

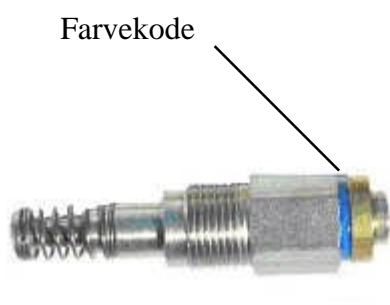

Farvekode	Ydelse pr. stempelslag	Varenr.
Rød	0,010 cm ³	78033
Grøn	0,015 cm ³	78034
Orange	0,025 cm ³	78035
Blå	0,040 cm ³	78036
Sølv	0,060 cm ³	78037
Sort	0,100 cm ³	78038
Prop		34237-402

Pumpens hastighed er 1,8 omdr. pr. min., dvs. at hvert pumpeelement bliver påvirket 108 gange pr. time,

Beregning af smøremiddelmængden:

Pumpens omdr. tal pr. time. × ydelse pr. pumpeelement = smøremiddelmængden i cm³/time.

Fittings og tilbehør

Ligeforskruning		
Beskrivelse	Materiale	Varenr.
GE4LLM6x1	Syrefast	223-13784-9
GE4LLxM6x1	Galv. Stål	223-12533-5
GE4xM6x1	Messing	5-007
GE4LL1/4UNF	Galv. Stål	9-114
GE4LLM8x1	Galv. Stål	223-12271-8
GE4xM8x1	Messing	5-008
GE4LLM10x1	Syrefast	9-133
GE4LLM10x1	Galv. Stål	223-13069-1
GE4M10x1	Messing	5-009
GE4LLR1/8	Syrefast	223-13614-8
GE4LLR1/8	Galv. Stål	223-12270-8
GE4xR1/8	Messing	5-020
GE4xG1/4	Messing	5-006
GE6LLM5x1	Galv. Stål	9-163
GE6LLM6x1	Syrefast	223-13658-7
GE6LLM6x1	Galv. Stål	223-12533-9
GE6xM6x1	Messing	7-027
GE6LLM6x0,75	Galv. Stål	9-240
GE6LL1/4UNF	Galv. Stål	9-103
GE6LL1/4x28UNF	Galv. Stål	9-149
GE6LL5/16UNF	Galv. Stål	9-179
GE6LLM8x1	Syrefast	223-13658-6
GE6LLM8x1	Galv. Stål	223-13023-1
GE6LLM8x1,25	Galv. Stål	9-127
GE6M8x1	Messing	7-028
GE6LLM10x1	Syrefast	223-13658-5
GE6LLM10x1	Galv. Stål	223-12271-7
GE6M10x1	Messing	7-029
GE6LM10x1	Galv. Stål	9-237
GE6LM10x1,25	Galv. Stål	9-187
GE6LM10x1,5	Galv. Stål	9-201
GE6xM10x1,5	Messing	7-074
GE6LLR1/8	Syrefast	223-13614-9
GE6LLR1/8	Galv. Stål	223-12270-7
GE6R1/8	Messing	69068

Fittings og tilbehør

Beskrivelse	Materiale	Varenr.
GE6LLR1/4	Galv. Stål	9-204
GE6LR1/4	Galv. Stål	223-12477-8
GE6R1/4	Messing	69069
GE6LR1/4	Syrefast	223-13658-9
GE8LR1/4	Galv. Stål	9-248
GE8LLM8x1,25	Galv. Stål	9-232
GE8LLM10x1	Galv. Stål	18-108-003

Union						
Beskrivelse	Materiale	D	H	L	Varenr.	
G4LL	Syrefast				9-0171	
G4LL	Galv. Stål				223-12531-8	
G4	Messing				5-010	
G6LL	Syrefast				223-12454-7	
G6LL	Galv. Stål				223-12482-9	
G6	Messing				69077	
GR6/4	Messing				5-046	
GR6LL/4LL	Galv. Stål				18-104-000-6	
GR10/6L	Syrefast				9-136	
GR10/6L	Galv. Stål				9-015	
G10L	Galv. Stål				223-12531-2	
G10	Messing				69078	
G12L	Syrefast				223-13615-7	
G12L	Galv. Stål				223-12278-9	
GR12/6L	Syrefast				9-063	
GR12/6L	Galv. Stål				9-074	
GR18/6L	Syrefast				9-162	
GR18/6 L	Galv. Stål				9-138	
G18L	Syrefast				9-160	
G18L	Galv. Stål				9-137	

Fittings og tilbehør

Vinkelforskruning		
Beskrivelse	Materiale	Varenr.
WE4LLM6x1	Syrefast	9-0165
WE4LLM6x1	Galv. Stål	223-12533-6
4M6x1udv	Messing	5-002
WE4LLM8x1	Syrefast	9-0166
WE4LLM8x1	Galv. Stål	223-13021-5
WE4LLM10x1	Galv. Stål	223-13069-2
4M10x1	Messing	5-000
4RG1/8	Messing	5-001
WE4LLR1/8	Syrefast	223-13677-8
WE4LLRG1/8	Galv. Stål	223-13021-4
4RG1/4	Messing	5-006
WE6LLM6x1	Syrefast	223-13677-4
WE6LLM6x1	Galv. Stål	223-13023-2
6M6x1	Messing	5-017
WE6LLM8x1	Syrefast	223-13677-2
WE6LLM8x1	Galv. Stål	223-13023-3
6xM8x1	Messing	5-021
WE6LLM8x1,25	Galv. Stål	223-13763-4
WE6LLM10x1	Syrefast	223-13677-3
WE6LLM10x1	Galv. Stål	223-13023-4
6M10x1	Messing	7-033
WE6LLR1/8	Syrefast	223-12453-7
WE6LLR1/8	Galv. Stål	223-12485-9
6RG 1/8	Messing	69079
WE6LR1/4K	Syrefast	223-13794-1
WE6LR1/4	Galv. Stål	223-13022-1
6RG1/4	Messing	69080

Fittings og tilbehør

Skotgennemføring med smørenippel		
Beskrivelse	Materiale	Varenr.
SV6LPT8	Syrefast	9-0161
SV6LPT12	Syrefast	9-0170
SV6LPT8	Galv. Stål	9-0159
SV6LPT20	Galv. Stål	9-0172
SV6PT6	Messing	9-018
WSV6LPT12	Syrefast	9-0162
WSV6LPT8	Galv. Stål	9-0160

Stilbar vinkel		
Beskrivelse	Materiale	Varenr.
SWV4xM6x1	Galv. Stål	3.2406.1
SWV4xM6x1	Messing	4.310438.1
SWV4xM8x1	Galv. Stål	3.2408.1
SWV4xM8x1,25	Galv. Stål	3.2409.1
SWV4xM10x1	Galv. Stål	3.2410.1
SWVRG1/8	Galv. Stål	3.2418.1
SWV6LLR1/8	Galv. Stål	223-12479-9
SWV6LLM10x1	Galv. Stål	223-12480-7
SWV6xM6x1	Galv. Stål	3.2606.1
SWV6xM8x1	Galv. Stål	3.2608.1
SWV6xM10x1	Galv. Stål	3.2610.1
SWV6xRG1/8	Galv. Stål	3.2618.1

Fittings og tilbehør

Beskrivelse	Materiale	Varenr.
4/2 140 bar	Nylon sort	9-001
4/2 140 bar	Nylon klar	9-044
6/3 250 bar	Nylon sort	9-002
6/3 250 bar fedtfyldt	Nylon sort	9-002-02
6/3 250 bar	Nylon klar	9-072
8,6x4 840 bar	Termoplast	9-081-1
8,6x4 840 bar fedtfyldt	Termoplast	9-202
11,3x6,35 840 bar fedtfyldt	Termoplast	18-100-011
11,3x6,35 840 bar	Termoplast	18-100-012

Fittings og tilbehør

Beskrivelse	Materiale	D	H	L	Varenr.
Koblingsmøtrik og slangestuds for slange Ø8,6x2					
Koblingsmøtrik	Galv. Stål				432-23031-1
Slangestuds lige	Galv. Stål	4		20	425100140054
Slangestuds lige, kort, ND	Galv. Stål	6		20	432-24162-1
Slangestuds lige, lang	Galv. Stål	6		30	432-23067-1
Slangestuds 90° lang	Galv. Stål	6	28	53	532-30738-1
Slangestuds 90° kort	Galv. Stål	6	13	21	532-30739-1
Slangestuds 90° mellem	Galv. Stål	6	28	37	425100100053
Slangestuds 90° mellem ND	Galv. Stål	6	25	37	425100100053-1
Slangestuds 90° kort mellem	Galv. Stål	6	17	28	425100100053-3
Slangestuds 45° kort	Galv. Stål	6	24	15	425100100057
Slangestuds 45° lang	Galv. Stål	6	35	25	425100100058
Slangestuds lige 6LL	Galv. Stål	6		39	18-3510-101
Slangestuds lige	Galv. Stål	8		30	18-100-051-8
Slangestuds m. 2 gevindender	Galv. Stål			25	18-100-061
Koblingsmøtrik	Syrefast				432-23676-1
Slangestuds lige	Syrefast	4			9-101
Slangestuds lige	Syrefast	6		30	432-23675-1
Slangestuds 90°	Syrefast	6	28	37	18-100-053-VA
Slangestuds lige	Syrefast	10			9-109

Fittings og tilbehør

Støttebøsning		
		
Beskrivelse	Materiale	Varenr.
Støttebøsning 4/2	Messing	8-8923
Støttebøsning 6/3	Messing	8-8922
Støttebøsning 6/4	Messing	4.370200.1
Støttebøsning 8/6	Messing	4.370380.1

Vinkel messing					
					
Beskrivelse	Materiale	D	H	L	Varenr.
Vinkel M6x1 udv x M8x1 indv.	Messing				18-104-121
Vinkel M8x1 udv x M8x1 indv.	Messing				18-104-122
Vinkel M10x1udv x M8x1 indv.	Messing				18-104-123
Tekawe omløbsskruer. M8x1	Messing	4			4.139104.1
Tekawe skæring	Messing	4			4.138824.1

Fittings og tilbehør

Montagebøjle til rør og slange			
Beskrivelse	Materiale	D	Varenr.
Bøjle f. 1 rør	Syrefast	4	64532-1
Bøjle f. 2 rør	Syrefast	4	64532-2
Bøjle f. 3 rør	Syrefast	4	64532-3
Bøjle f. 4 rør	Syrefast	4	64532-4
Bøjle f. 5 rør	Syrefast	4	64532-5
Bøjle f. 6 rør	Syrefast	4	64532-6
Bøjle f. 1 rør	Syrefast	6	64533-1
Bøjle f. 2 rør	Syrefast	6	64533-2
Bøjle f. 3 rør	Syrefast	6	64533-3
Bøjle f. 4 rør	Syrefast	6	64533-4
Bøjle f. 5 rør	Syrefast	6	64533-5
Bøjle f. 6 rør	Syrefast	6	64533-6
Bøjle f. 7 rør	Syrefast	6	64533-7
Bøjle f. 8 rør	Syrefast	6	64533-8
Bøjle f. 9 rør	Syrefast	6	64533-9
Bøjle f. 10 rør	Syrefast	6	64533-10
Bøjle f. 11 rør	Syrefast	6	64533-11
Bøjle f. 12 rør	Syrefast	6	64533-12

Fittings og tilbehør

Rørbøjler med gummi indlæg			
Beskrivelse	Materiale	D	Varenr.
Bøjle f. nylonslange	Galv.Stål	6	226-12557-1
Bøjle f. nylonslange	Syrefast	6	226-12557-11
Bøjle f. højtryksslange	Galv.Stål	8	226-12557-2
Bøjle f. højtryksslange	Syrefast	8	226-12557-22
Bøjle f. højtryksslange	Galv.Stål	11	226-12557-3
Bøjle f. højtryksslange	Syrefast	11	226-12557-33
Bøjle f. højtryksslange	Syrefast	13	226-12557-77
Bøjle f. højtryksslange	Galv.Stål	16	226-12557-4
Bøjle f. højtryksslange	Syrefast	16	226-12557-44
Bøjle f. højtryksslange	Syrefast	18	9-106
Bøjle f. højtryksslange	Galv.Stål	19	9-094
Bøjle f. højtryksslange	Galv.Stål	21	226-12557-6
Bøjle f. højtryksslange	Syrefast	21	226-12557-66
Bøjle f. højtryksslange	Galv.Stål	25	226-12557-8
Bøjle f. højtryksslange	Galv.Stål	29	226-12557-9
Bøjle f. højtryksslange	Galv.Stål	38	9-257

Spiralflex			
Beskrivelse	Materiale	D	Varenr.
Spiralflex	Plastik	8,5x11,5	283563600558
Spiralflex	Plastik	17x21	283563600559

Fittings og tilbehør

Skærring			
Beskrivelse	Materiale	D	Varenr.
Skærring 4	Messing	4	5-013
Skærring 4LL	Syrefast	4	9-128
Skærring 4LL	Galv.Stål	4	223-12295-1
Skærring 5	Messing	5	5-042
Skærring 6L	Syrefast	6	9-131
Skærring 6LL	Syrefast	6	9-132
Skærring 6LL	Galv.Stål	6	223-12295-2
Skærring 6LL	Messing	6	5-056
Skærring 6L/S	Galv.Stål	6	9-066
Skærring 6L/S	Messing	6	69098-6
Skærring 8	Messing	8	5-016
Skærring 8L	Galv.Stål	8	9-061
Skærring 8LL	Galv.Stål	8	9-209
Skærring 10	Messing	10	69099-10
Skærring 10L	Galv.Stål	10	9-051
Skærring 12 L	Syrefast	12	9-097
Skærring 12 L	Galv.Stål	12	9-080

Fittings og tilbehør

Omløber			
Beskrivelse	Materiale	D	Varenr.
Omløber 4	Messing	4	5-012
Omløber 4LL	Syrefast	4	9-129
Omløber 4LL	Galv.Stål	4	223-13032-1
Omløber 6	Messing	6	69100-6
Omløber 6L	Syrefast	6	9-130
Omløber 6L	Galv.Stål	6	223-12374-10
Omløber 6LL	Syrefast	6	223-13638-2
Omløber 6LL	Galv.Stål	6	223-12374-9
Omløber 8L	Galv.Stål	8	9-214
Omløber 10 L	Galv.Stål	10	9-056
Omløber 12L	Galv.Stål	12	9-079
Omløber 12 L	Syrefast	12	9-262
Omløber 6 Svær	Syrefast	6	5-055
Omløber 6 Svær	Galv.Stål	6	5-030
Omløber 6 Svær	Messing	6	69100-6S
Omløber 8 Svær	Galv.Stål	8	9-213
Omløber 10 Svær	Messing	10	69101-10S

Ligeforskruning md indiv. gevind			
Beskrivelse	Materiale	D	Varenr.
Ligeforskruning RG1/4 indiv.	Messing	6	69074
Ligeforskruning RG1/8 indiv.	Messing	4	5-019
Ligeforskruning RG1/8 indiv.	Messing	6	69073
Ligeforskruning M10x1 indiv.	Messing	6	69073-1
Ligeforskruning M10x1,5 indiv.	Messing	6	69073-2

Fittings og tilbehør

Vinkelforskruning med indv. gevind			
Beskrivelse	Materiale	D	Varenr.
Vinkelfor. RG1/8 indv.	Messing	4	66935
Vinkelfor. RG1/8 indv.	Messing	6	69084

Nippelmuffe			
Beskrivelse	Materiale	Varenr.	
RG 1/8 indv. x RG1/4 udv.	Messing Fornik.	10461	
RG 1/8 indv. x RG 3/8 udv.	Messing Fornik.	67366	
RG 1/4 indv. x RG3/8 udv.	Messing	7-038	
RG 1/4 indv. x RG1/2	Messing	10204	
RG 3/8 udv. x RG1/4indv.	Galv.Stål	10049	
RG1/4 indv. x 3/8 udv.	Messing Fornik.	67365	
M10x1 indv. x 3/8 udv.	Messing	7-078	
M12x1udv.x M8x1 indv.	Messing	7-073	

Fittings og tilbehør

Brystnippel		
		
Beskrivelse	Materiale	Varenr.
Brystnippel M8x1	Messing	5-031
Brystnippel M18x1,5 x M14x1,5	Galv.Stål	9-254
Brystnippel RG1/8 x RG1/8	Messing	10130
Brystnippel RG1/8 x 1/4	Syrefast	9-193
Brystnippel RG1/8xRG1/8	Syrefast	9-167
Brystnippel RG1/8 udv. x RG 1/4	Messing	10772
Brystnippel RG1/4 x RG1/4	Messing	10462
Brystnippel RG3/8	Messing	10540
Brystnippel RG 1/4 x M20x1,5	Galv.Stål	9-197
Brystnippel RG 1/4 x M22x1,5	Galv.Stål	9-166
Brystnippel RG 3/8 udv. x RG 1/4	Messing	10773

Muffe		
		
Beskrivelse	Materiale	Varenr.
Muffe RG1/8	Syrefast	6-001
Muffe RG1/8	Galv.Stål	6-004
Muffe RG1/8	Messing	67360
Muffe RG1/4	Galv.Stål	6-005
Muffe RG 1/4	Messing	67361
Muffe M10x1	Syrefast	6-104
Muffe M14x2 x RG1/4	Syrefast	9-280

Fittings og tilbehør

Prop			
			
Beskrivelse	Materiale	Varenr.	
Prop RG1/8	Messing	5-022	
Prop RG1/4	Messing	5-023	
Prop RG3/8	Messing	5-018	
Prop M8x1	Galv.Stål	303-16284-1	
Prop M10x1	Galv.Stål	430022	

Pensler			
			
Beskrivelse	Materiale	D	Varenr.
Pensel 20x4 mm RG 1/8 indv.	Nylon		8-014
Pensel 40x8 mm RG 1/8 udv.	Nylon		8-010
Pensel 60x8 mm RG 1/8 udv.	Nylon		8-001
Pensel 75x8 mm RG 1/8 udv	Nylon		8-016
Pensel til ø4 mm rør	Nylon	10	2.0904.1
Pensel M8x1 indv.	Nylon	11	8-007
Pensel M8x1 indv.	Nylon	17	8-008
Pensel RG1/8 udv.	Nylon	20	8-8978
Pensel M8x1 indv.	Nylon	25	8-009
Pensel M8x1 indv.	Messing	16	8-011
Pensel M8x1 indv.	Messing	20	8-012
Pensel M10x1 indv.	Nylon	25	8-009-1
Pensel RG 1/8 indv.	Nylon	25	8-017
Pensel 30x40 RG1/4	Nylon		7-034
Pensel 30x70 RG1/4	Nylon		7-035
Pensel 100x30 mm RG1/4	Nylon		8-018
Pensel 90° til 4 mm rør	Klaverstreng	10	8-015
Pensel til ø6 mm rør	Klaverstreng	10	8-020
Pensel m.2 ben RG1/8 indv.	Nylon	15	8-019

Fittings og tilbehør

Lige push-in fittings for nylonslange			
Beskrivelse	Materiale	D	Varenr.
Lige push-in fittings M6x1	Forz. Messing	4	226-13752-3
Lige push-in fittings M8x1	Forz. Messing	4	226-13752-1
Lige push-in fittings M10x1	Forz. Messing	4	226-13752-2
Lige push-in fittings RG1/8	Forz. Messing	4	226-13752-4
Lige push-in fittings M6x1	Forz. Messing	6	226-13752-8
Lige push-in fittings M8x1	Forz. Messing	6	226-13752-7
Lige push-in fittings M10x1	Forz. Messing	6	226-13752-6
Lige push-in fittings RG1/	Forz. Messing	6	226-13752-9
Lige push-in fittings RG1/4	Forz. Messing	6	2.750372.1

Vinkel push-in fittings for nylonslange			
Beskrivelse	Materiale	D	Varenr.
Vinkel push-in fittings M6x1	Forz. Messing	4	226-13753-5
Vinkel push-in fittings M8x1	Forz. Messing	4	226-13753-1
Vinkel push-in fittings M10x1	Forz. Messing	4	226-13753-2
Vinkel push-in fittings RG1/8	Forz. Messing	4	226-13753-3
Vinkel push-in fittings M6x1	Forz. Messing	6	226-13753-7
Vinkel push-in fittings M8x1	Forz. Messing	6	226-13753-8
Vinkel push-in fittings M10x1	Forz. Messing	6	226-13753-6
Vinkel push-in fittings RG1/8	Forz. Messing	6	226-13753-4

Fittings og tilbehør

Stilbar vinkel push-in fittings for nylonlange			
Beskrivelse	Materiale	D	Varenr.
Stilbar vinkel push-in fit. M6x1	Forz. Messing	4	226-13756-6
Stilbar vinkel push-in fit. M8x1	Forz. Messing	4	226-13756-1
Stilbar vinkel push-in fit. M10x1	Forz. Messing	4	226-13756-2
Stilbar vinkel push-in fit. RG1/8	Forz. Messing	4	226-13756-3
Stilbar vinkel push-in fit. M6x1	Forz. Messing	6	226-13756-7
Stilbar vinkel push-in fit. M8x1	Forz. Messing	6	226-13756-4
Stilbar vinkel push-in fit. M10x1	Forz. Messing	6	226-13756-5
Stilbar vinkel push-in fit. RG1/8	Forz. Messing	6	226-13756-8
Stilbar vinkel push-in fit. RG1/4	Forz. Messing	6	2.750772.1

Union push-in fittings for nylonlange			
Beskrivelse	Materiale	D	Varenr.
Union push-in fittings	Forz. Messing	4	226-13773-1
Union push-in fittings	Forz. Messing	6	226-13773-3

Lige Drejeled			
Beskrivelse	Tryk i bar	Rpm	Varenr.
Drejeled RG1/8 udv.xRG1/8 indiv.	80	300	91308
Drejeled RG1/4 udv.xRG1/4 indiv.	250	60	9-100

Fittings og tilbehør

Vinkel Drejeled				
Beskrivelse	Materiale	Bar	Rpm	Varenr.
RG1/8 udv.x RG1/8 indv.	Galv.Stål	80	300	91048
RG1/8 udv.x RG1/8 indv.	Galv.Stål	500	400	81723
RG1/8 med 2 drejelige sektioner	Galv.Stål	500	400	82251
1/8 NPT med 3 drejelige sektioner	Galv.Stål	500	400	82252
RG1/8udv.xRG1/8 indv.	Galv.Stål	55	75	10-052
RG1/4udv.x RG1/4 indv.	Galv.Stål	30	75	10-053
M6x1udv. x M8x1 indv.	Rustfri	30	100	9-153
M8x1udv. x M8x1 indv.	Rustfri	30	100	9-154
M10x1udv.xM8x1 indv.	Rustfri	30	100	9-155
RG1/8 udv.xM8x1indv.	Rustfri	30	100	9-156

Fittings og tilbehør

Forlænger			
Beskrivelse	Materiale	L	Varenr.
M4 indv x M4 udv.	Galv.Stål	20	7-090
M6x0,75 indv x M6x0,75 udv.	Rustfri	43	7-099
M6x1 indv.x M6x1 udv.	Galv.Stål	10	7-055
M6x1 indv.x M6x1 udv.	Galv.Stål	15	7-056
M6x1 indv x M6x1 udv.	Rustfri	20	7-098
M6x1 indv.x M6x1 udv.	Galv.Stål	20	7-057
M6x 1indv.x M6x1 udv.	Galv.Stål	50	7-071
M8x 1 indv.x M8x1 udv.	Galv.Stål	10	18-100-130
M8x 1 indv.x M8x1 udv.	Galv.Stål	12	4.1408.1
M8x 1 indv.x M8x1 udv.	Galv.Stål	24	18-100-132
M8x1 indv.x M6x1 udv.	Galv.Stål	10	18-100-120
M10x1 indv. x RG1/8" udv.	Galv.Stål	10	18-100-151
M10 indv. x 1/4 udv.	Galv.Stål	13	18-100-144
M10x 1 indv. x M10x1 udv.	Galv.Stål	10	18-100-142
M10x 1 indv. x M10x1 udv.	Galv.Stål	15	18-100-141
M10x 1 indv. x M10x1 udv.	Galv.Stål	27	18-100-145
M10x 1 indv. x M10x1 udv.	Galv.Stål	32	18-100-143
M10x 1indv. x M10x1udv.	Galv.Stål	43	18-100-146
M10x 1 indv. x M10x1,5 udv.	Rustfri	18	7-081
M10x1 indv. x M8x1 udv.	Galv.Stål	15	18-100-137
RG1/8 indv. x RG1/8 udv.	Galv.Stål	10	304-19230-1-18
RG1/8 indv. x RG1/8 udv.	Rustfri	15	7-087
RG1/8 indv. x RG1/8 udv.	Galv.Stål	15	304-19230-1-25
RG1/8 indv. x RG1/8 udv.	Galv.Stål	25	304-19230-1-35
RG1/8 indv. x RG1/8" udv.	Galv.Stål	34	304-19230-1-41
RG1/8 indv. x RG 1/8 udv.	Rustfri	34	7-077
RG1/8 indv. x RG1/8 udv.	Galv.Stål	40	304-19230-1-50
RG1/8 indv. x RG1/8 udv.	Galv.Stål	50	304-19230-1-60
RG1/8 indv. x M10x1,5udv.	Rustfri	23	7-079
RG1/4"indv x RG1/4"	Galv.Stål	16	18-100-161
RG1/4 indv. x RG1/4 udv.	Rustfri	20	7-091
RG1/4 indv. x RG1/4 udv.	Rustfri	75	7-093
RG1/4 indv. x RG1/4 udv.	Rustfri	150	7-094

Fittings og tilbehør

Forlænger Vinkel		
		
Beskrivelse	Materiale	Varenr.
45° RG1/8"indv.xRG1/8"udv.	Galv.Stål	20028
45° M8x1 indv. x M6x1 udv.	Galv.Stål	18-100-821
45° M8 x1 indv.x M8 x1 udv.	Galv.Stål	18-100-822
45° M10 x1 indv.x M10 x1 udv.	Galv.Stål	18-100-833
90° 1/8NPTx1/8NPT	Galv.Stål	18-5011-101
90° RG1/8 indv.xRG1/8 udv.	Galv.Stål	20029
90° RG1/8 indv.xRG1/4x28udv	Galv.Stål	20026
90° M6x1indv.xM6x1udv.	Galv.Stål	18-100-711
90° M8x1indv.xM8x1udv.	Galv.Stål	18-100-722
90° M10x1 indv.xM6x1 udv.	Galv.Stål	18-5011-105
90° M10x1 indv.xM10 x1udv.	Galv.Stål	18-100-733

Lynkoblinger		
		
Beskrivelse	Materiale	Varenr.
Hun RG1/4 indv. Hansen ISO B	Galv.Stål	8-8500
Han RG1/4 indv. Hansen ISO B	Galv.Stål	8-8499
Hun RG1/4 indv. skrue	Galv.Stål	8-8503
Han RG1/4 indv. skrue	Galv.Stål	8-8504